

On a Generalisation of Dillon's APN Permutation

Anne Canteaut

Anne.Canteaut@inria.fr

Sébastien Duval

Sebastien.Duval@inria.fr

Léo Perrin

leo.perrin@uni.lu

April 24, 2017



Table of Contents

- 1 Introduction
- 2 Generalisation of Butterflies
- 3 Properties of Generalised Butterflies
- 4 Walsh Spectrum and Table of Differences
- 5 Conclusion

S-Box

Definition 1 (S-Box)

We will call *Substitution-Box* or *S-Box* any mapping from \mathbb{F}_2^m into \mathbb{F}_2^n , $n, m \geq 0$.

Main Desirable Properties

- ▶ Permutation ($\Rightarrow n = m$)
- ▶ Non-linear ($\Rightarrow n$ small)
- ▶ Resistant to differential attacks
- ▶ Resistant to linear attacks
- ▶ High algebraic degree

Differential Properties

Definition 2 (Differential Uniformity)

Let F be a function over \mathbb{F}_2^n . The table of differences of F is:

$$\delta_F(a, b) = \#\{x \in \mathbb{F}_2^n \mid F(x \oplus a) = F(x) \oplus b\}.$$

Moreover, the differential uniformity of F is

$$\delta(F) = \max_{a \neq 0, b} \delta_F(a, b).$$

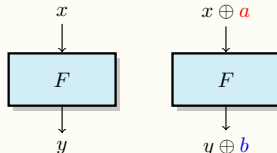

- ▶ F is resistant against differential attacks if $\delta(F)$ is small
- ▶ F is called **APN** if $\delta(F) = 2$

The Big APN Problem

The Big APN Problem

We know how to get:

- ▶ APN functions on \mathbb{F}_2^n ,
- ▶ APN permutations on \mathbb{F}_2^n , n odd,
- ▶ permutations with $\delta = 4$ on \mathbb{F}_2^n .

Are there any APN permutations on \mathbb{F}_2^n , n even ?

2009: Dillon S-Box

Browning, Dillon, McQuistan, Wolfe: APN permutation on \mathbb{F}_2^6 .

The Still Big APN Problem

Are there any other APN permutations on \mathbb{F}_2^n , n even ?

Linear Properties

Definition 3 (Linearity)

Let F be a function over \mathbb{F}_2^n . The table of linear biases of F is:

$$\lambda_F(a, b) = \sum_{x \in \mathbb{F}_2^n} (-1)^{a \cdot x \oplus b \cdot F(x)}.$$

Moreover, the linearity of F is

$$\mathcal{L}(F) = \max_{a, b \neq 0} |\lambda_F(a, b)|.$$

- ▶ F is resistant to linear attacks if $\mathcal{L}(F)$ is small

Algebraic Degree

Definition 4 (Univariate degree vs algebraic degree)

Let F be a function from \mathbb{F}_2^n into \mathbb{F}_2^n .

The *algebraic degree* (aka multivariate degree) of F is the maximal degree of the algebraic normal forms of its coordinates.

The *univariate degree* of F is the degree of the univariate polynomial in $\mathbb{F}_{2^n}[X]$ representing F when it is identified with a function from \mathbb{F}_{2^n} into itself.

The algebraic degree of the univariate polynomial $x \mapsto x^e$ of \mathbb{F}_{2^n} is the Hamming weight of the binary expansion of e .

Butterflies: Definitions (1) [Perrin et al.]

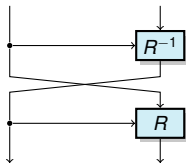

H_R : Open Butterfly

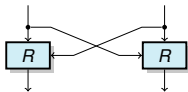

V_R : Closed Butterfly

$R_k : x \mapsto R(x, k)$ permutation $\forall k$.

Open Butterfly and Closed Butterfly are
CCZ-equivalent \Rightarrow share the same sets

$$\{\delta_{H_R}(a, b)\}_{a,b} = \{\delta_{V_R}(a, b)\}_{a,b},$$

$$\{\mathcal{L}_{H_R}(a, b)\}_{a,b} = \{\mathcal{L}_{V_R}(a, b)\}_{a,b}.$$

In particular, $\delta(H_R) = \delta(V_R)$ and
 $\mathcal{L}(H_R) = \mathcal{L}(V_R)$.

Butterflies: Definitions (2)

$$R_k[e, \alpha] = (x \oplus \alpha k)^e \oplus k^e, \text{ with } \gcd(e, 2^n - 1) = 1.$$

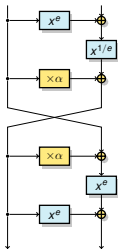

H_R : Open Butterfly

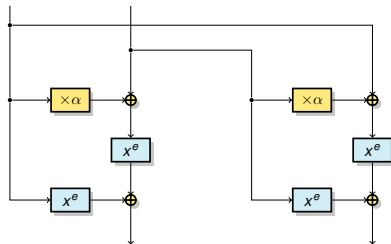

V_R : Closed Butterfly

Most interesting case for study: $e = 3 \times 2^t$.
Then R is **quadratic**, and V_R is **quadratic**.

Butterflies: Properties

Theorem 1 (Properties of Butterflies)

Let $e = 3 \times 2^t$, $\alpha \notin \{0, 1\}$, n odd.

- ▶ $\delta(H_R) \leq 4$, $\delta(V_R) \leq 4$,
- ▶ V_R is quadratic,
- ▶ H_R has algebraic degree $n + 1$.

Theorem 2 (APN Butterflies)

If $n = 3$ and $x \mapsto x^e$ is APN, then H_R is an APN permutation (affine equivalent to the Dillon permutation).

Open Questions of [Perrin et al.]

Open Questions of [Perrin et al.]

- ▶ Nonlinearity/Linearity of H_R (and V_R),
- ▶ Can we find α such that H_R is APN for some $n > 6$?

Generalised Butterflies: Definitions

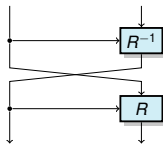

$H_{\alpha,\beta}$: *Open Butterfly*

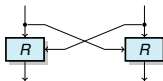

$V_{\alpha,\beta}$: *Closed Butterfly*

Degree restriction:

- ▶ $R_y : x \mapsto R(x, y)$ permutation $\forall y$.
- ▶ Degree of R is at most 3:
- ▶ Then R can be written:

$$R(x, y) = (x \oplus \alpha y)^3 \oplus \beta y^3$$

with $\alpha, \beta \in \mathbb{F}_2^n$.

Generalised Butterflies: Definitions (2)

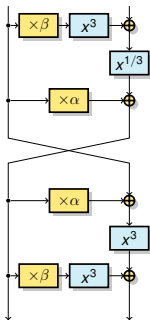

$H_{\alpha, \beta}$: Open Butterfly

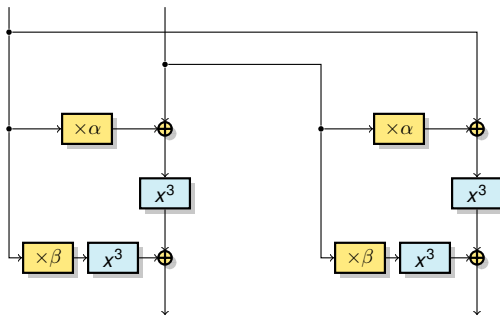

$V_{\alpha, \beta}$: Closed Butterfly

Equivalences

- ▶ $H_{\alpha,\beta}$ and $V_{\alpha,\beta}$ are CCZ-equivalent.
- ▶ When $\alpha = 1$, $H_{\alpha,\beta}$ is equivalent to a 3-round Feistel network.
- ▶ Butterfly with $e = 3 \times 2^t$ is affine-equivalent to Butterfly with $e = 3$.
- ▶ $V_{\alpha,\beta}$ and V_{α^2,β^2} are affine-equivalent.
- ▶ If $\alpha \neq 1$, $V_{\alpha,\beta}$ and $V_{\alpha,\beta^{-1}(1+\alpha)^6}$ are affine-equivalent.

Property of Quadratic Functions

Property 1 (Linearity of Quadratic Functions)

Let f be a quadratic Boolean function of n variables.

$$\text{LS}(f) = \{a \in \mathbb{F}_2^n : D_a f \text{ is constant}\}$$

Then $\mathcal{L}(f) = 2^{\frac{n+s}{2}}$, with $s = \dim \text{LS}(f)$.

Moreover, the Walsh coefficients of f only the values $\pm 2^{\frac{n+s}{2}}$ and 0.

Linear Properties

Theorem 3

Let $n > 1$ be an odd integer and (α, β) be a pair of nonzero elements in \mathbb{F}_{2^n} .

- ▶ If $\beta \neq (1 + \alpha)^3$,

$$\mathcal{L}(V_{\alpha,\beta}) = 2^{n+1}$$

and the Walsh coefficients of $V_{\alpha,\beta}$ belong to $\{0, \pm 2^n, \pm 2^{n+1}\}$.

- ▶ If $\beta = (1 + \alpha)^3$,

$$\mathcal{L}(V_{\alpha,\beta}) = 2^{\frac{3n+1}{2}}.$$

Differential Properties

Theorem 4 (Differential uniformity)

Let $n > 1$ odd, $\alpha, \beta \in \mathbb{F}_{2^n} \setminus \{0\}$. Then:

- ▶ If $\beta \neq (1 + \alpha)^3$, $\delta(H_{\alpha,\beta}) \leq 4$.
- ▶ If $\beta = (1 + \alpha)^3$, $\delta(H_{\alpha,\beta}) = 2^{n+1}$.

Theorem 5 (APN Condition)

Let $\alpha \neq 0, 1$. $H_{\alpha,\beta}$ is APN if and only if:

$$\beta \in \{(\alpha + \alpha^3), (\alpha^{-1} + \alpha^3)\} \text{ and } \text{Tr}(\mathcal{A}_\alpha(\mathbf{e})) = 1, \forall \mathbf{e} \notin \{0, \alpha, 1/\alpha\},$$

where $\mathcal{A}_\alpha(\mathbf{e}) = \frac{\mathbf{e}\alpha(1+\alpha)^2}{(1+\alpha\mathbf{e})(\alpha+\mathbf{e})^2}$.

This condition implies that $n = 3$.

Algebraic Degree

Theorem 6

Let α and β be two nonzero elements in \mathbb{F}_{2^n} .

$H_{\alpha,\beta}$ has an algebraic degree equal to n or $n + 1$.

It is equal to n if and only if

$$(1 + \alpha\beta + \alpha^4)^3 = \beta(\beta + \alpha + \alpha^3)^3.$$

$\alpha = 1$: 3-round Feistel Network

Proposition 1

For $\alpha = \beta = 1$, the difference distribution tables of the butterflies $V_{1,1}$ and $H_{1,1}$ contain the values 0 and 4 only.

Generalised Butterflies

Corollary 7 (Walsh and differential spectra of generalised butterflies)

Let α and β be two nonzero elements in \mathbb{F}_{2^n} such that $\beta \neq (1 + \alpha)^3$.

- ▶ *Walsh spectrum:*

$$\left| \widehat{H_{\alpha, \beta}}(u, v) \right| = \begin{cases} 0, & 3 \times 2^{2n-2}(2^n - 1)(2^n + 1 - C) \text{ times} \\ 2^n, & 2^{2n}(2^n - 1)C \text{ times} \\ 2^{n+1}, & 2^{2n-2}(2^n - 1)(2^n + 1 - C) \text{ times.} \end{cases}$$

where $(2^n - 1)C$ is the number of bent components of $V_{\alpha, \beta}$.

- ▶ *Table of differences:*

$$\delta_{H_{\alpha, \beta}}(a, b) = \begin{cases} 2, & 2^{2n-2}(2^n - 1) \times 3C \text{ times} \\ 4, & 2^{2n-3}(2^n - 1)(2^{n+2} + 4 - 3C) \text{ times} \end{cases}$$

New Permutations

Value of C for a Butterfly on 6 bits (\mathbb{F}_{2^3} defined by the primitive element a such that $a^3 + a + 1 = 0$).

$\alpha \backslash \beta$	1	a	a^2	a^3	a^4	a^5	a^6
1	0	4	4	4	4	4	4
a	6	2	0	2	6	0	0
a^3	2	4	2	0	2	4	2

These permutations are **new**:

- ▶ The value of C determines the differential and Walsh spectra,
- ▶ The case $\beta = 1$ does not include all possible values for C
 \Rightarrow the generalisation gives new permutations,
- ▶ **Differential/Linear spectra are different** from any other studied permutations, for example:
 - ▶ For $n = 3$, the number of 4 in the differential spectrum is in $\{0, 336, 672, 1008\}$,
 - ▶ Gold and Kasami permutations: number of 4 = 1008,
 - ▶ Inverse mapping: number of 4 = 63,

Conclusion

This work in brief:

- ▶ We answered the 2 open questions from Perrin et al.,
- ▶ We identified a new family of $2n$ bit-functions, $n \geq 3$ odd with:
 - ▶ differential uniformity 4,
 - ▶ linearity 2^{n+1} ,
 - ▶ a simple representation (easier implementation and analysis),
 - ▶ the permutation from Dillon et al. included.
- ▶ We proved that this natural generalisation does not contain any new APN permutation. :-)

Questions ?